

Section 11

Manufacturing Equipment

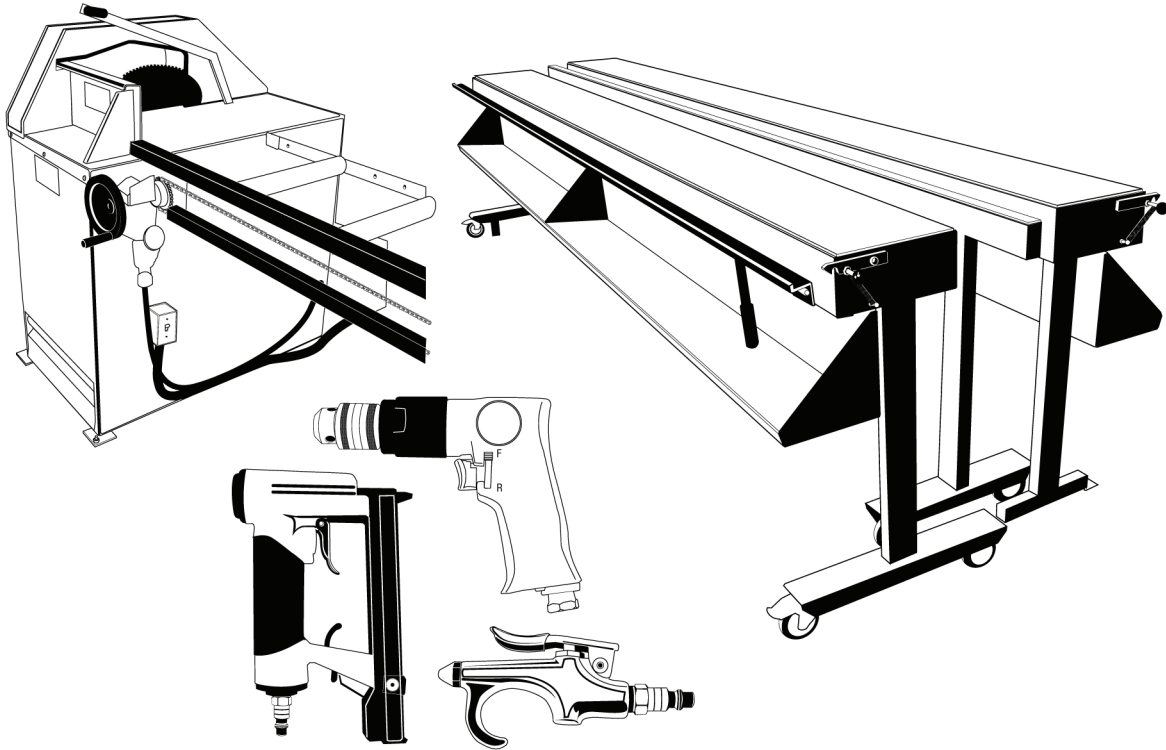

Endlocking Bench

Specially crafted table that aides in curtain assembly. Expandable table allows variance in curtain sizes, with additional rolling center support to prevent sagging in larger curtains.

Saw and Blades

Saw for accurate cutting of rolling shutter profiles and box covers. Designed for high precision and burr free cut. Feeding tables with electronic or manual read out available.

Pneumatic Tools

Recommended dependable tools for rolling shutter assembly.

MANUFACTURING EQUIPMENT

Endlocking Bench (Manual)

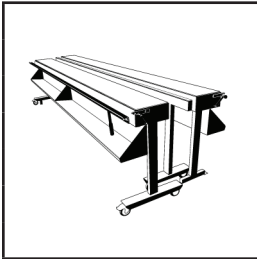
	Part Number	Description	Unit
	9506-ACCE-00-ST	Extendable - Complete with 2 Safety Rails Each 3 mtr	PC

Endlocking Bench (Pneumatic)

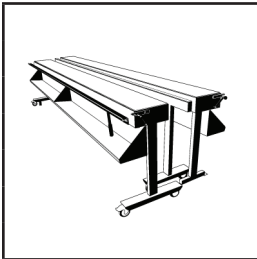
	Part Number	Description	Unit
	9507-ACCE-00-ST	Extendable - Complete 3 mtr	PC

Saws RPS600 Cross-Cut Saw - Manual Read Out 3x220v 60hz with 2 Roller Beds, 4mtr and 5mtr

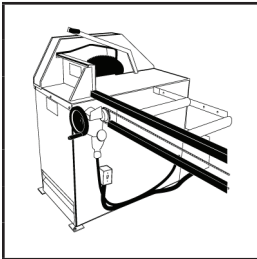
	Part Number	Description	Unit
	9509-ACCE-00-ST	Manual Measuring Device, Left Or Right Stop Custom Length of Tables Available	PC

Saws RPS600 Cross-Cut Saw - Electronic Read Out 3x220v 60hz With 2 Roller Beds, 4mtr and 5mtr

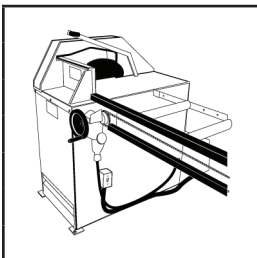
	Part Number	Description	Unit
	9508-ACCE-00-ST	Electronic Measuring Device, Left Or Right Stop Custom Length of Tables Available	PC

MANUFACTURING EQUIPMENT

Cushion Pack Machine

	Part Number	Description	Unit
	9550-ACCE-00-ST	1.1kw motor 230/240v/100-115v-50/60hz	PC
		Turns old cardboard into packaging material	

Saw Blade For Rps600 Cross-Cut Saw

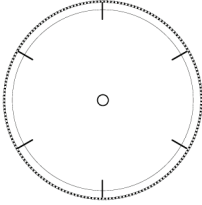
	Part Number	Description	Unit
	9515-ACCE-00-ST	Saw Blade 500 mm x 4.6 mm x 30 mm (19.68")	PC
	9516-ACCE-00-ST	Saw Blade 600 mm x 4.6 mm x 30 mm (23.62")	PC

Pneumatic Tools

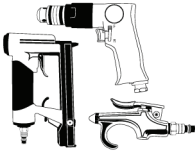
	Part Number	Description	Unit
	9500-ACCE-00-ST	Pneumatic Staple Gun (For 3 mm, 4 mm, & 6 mm Staples)	PC
	9501-ACCE-00-ST	Pneumatic Drill (For removing foam from foam filled aluminum profiles)	PC
	9503-ACCE-00-ST	Pneumatic Air Blower	PC

Locking Tongs for RLL3 & RLL4

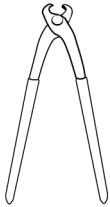
	Part Number	Description	Unit
	9502-ACCE-00-ST	Locking Tongs (For RLL-3 & RLL-4 Base Slat)	PC

Staples (Rust-Proof) 10,000/Per Box

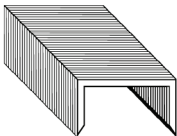
	Part Number	Description	Unit
	9425-ACCE-14-ST	3mm For CD - 90 and CD-100	BX
	9426-ACCE-14-ST	4mm For A - 150 and A -180	BX
	9427-ACCE-14-ST	6mm For A - 200 and A -240	BX

