

# Section 7

## Motors & Accessories

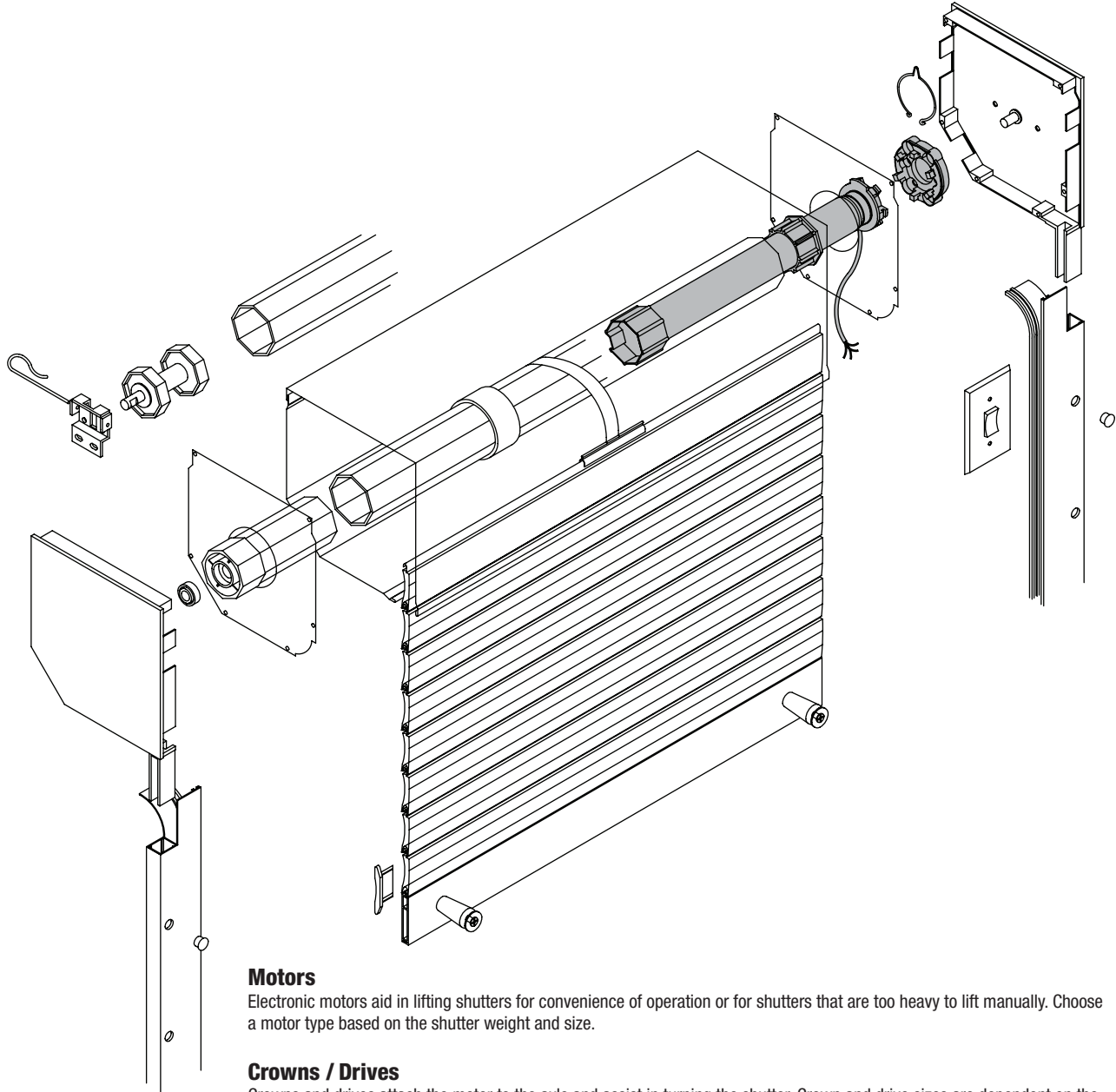

### **Motors**

Electronic motors aid in lifting shutters for convenience of operation or for shutters that are too heavy to lift manually. Choose a motor type based on the shutter weight and size.

### **Crowns / Drives**

Crowns and drives attach the motor to the axle and assist in turning the shutter. Crown and drive sizes are dependent on the size of the motor and axle.

### **Mounting Brackets**

Mount the shutter to the building fascia.

# SOMFY MOTORS

## Section 7 - Motors & Components

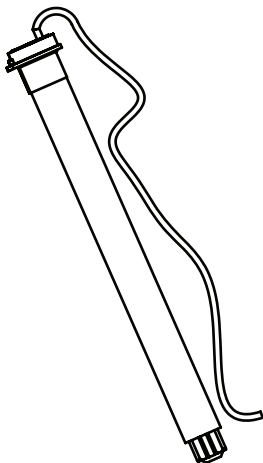

### Somfy LT50 Motors

Part Number	Description	Unit
8005-MOTO-00-ST	510R2 ELC*: 39 lbs / 60 mm Octagonal Tube, 40% SF.14 rpm	PC
8008-MOTO-00-ST	515A2 ELC*: 58 lbs / 60 mm Octagonal Tube, 40% SF.20 rpm	PC
8010-MOTO-00-ST	520R2 ELC*: 77 lbs / 60 mm Octagonal Tube, 40% SF.14 rpm	PC
8015-MOTO-00-ST	525A2 ELC*: 97 lbs / 60 mm Octagonal Tube, 40% SF.20 rpm	PC
8020-MOTO-00-ST	530R2 ELC*: 117 lbs / 60 mm Octagonal Tube, 40% SF.14 rpm	PC
8029-MOTO-00-ST	535A2 ELC*: 136 lbs / 60 mm Octagonal Tube, 40% SF.20 rpm	PC
8034-MOTO-00-ST	540R2 ELC*: 156 lbs / 60 mm Octagonal Tube, 40% SF.14 rpm	PC
8038-MOTO-00-ST	550R2 ELC*: 195 lbs / 60 mm Octagonal Tube, 40% SF.14 rpm	PC

### Somfy Altus 50 RTS - Radio Technology with Electronic Limit Switch

Part Number	Description	Unit
8019-MOTO-00-ST	525A2 ALTUS RTS ELC*: 97 lbs / 60 mm Oct. Tube, 20 rpm	PC
8023-MOTO-00-ST	530R2 ALTUS RTS ELC*:117 lbs / 60 mm Oct. Tube, 14 rpm	PC
8024-MOTO-00-ST	535A2 ALTUS RTS ELC*:136 lbs / 60 mm Oct. Tube, 20 rpm	PC
8022-MOTO-00-ST	540R2 ALTUS RTS ELC*:156lbs / 60 mm Oct. Tube, 14 rpm	PC
8039-MOTO-00-ST	550R2 ALTUS RTS ELC*:195 lbs / 60 mm Oct. Tube, 14 rpm	PC

### Somfy LT60 Motors

Part Number	Description	Unit
8045-MOTO-LT-60	660R2 ELC*: 212 lbs / 70 mm Octagonal Tube, 40% SF.14 rpm	PC
8047-MOTO-LT-60	680R2 ELC*: 280 lbs / 70 mm Octagonal Tube, 40% SF.14 rpm	PC
8049-MOTO-LT-60	6100R2 ELC*: 352 lbs / 70 mm Octagonal Tube, 40% SF.14 rpm	PC

### Somfy Altus 60 RTS - Radio Technology with Electronic Limit Switch

Part Number	Description	Unit
8013-MOTO-00-ST	660R2 ALTUS RTS ELC*: 212 lbs / 70 mm Oct. Tube, 14 rpm	PC
8041-MOTO-00-ST	680R2 ALTUS RTS ELC*: 280 lbs / 70 mm Oct. Tube, 14 rpm	PC
8044-MOTO-00-ST	6100R2 ALTUS RTS ELC*: 352 lbs / 70 mm Oct. Tube, 14 rpm	PC

\*Effective Lifting Capacity

# SOMFY MOTORS

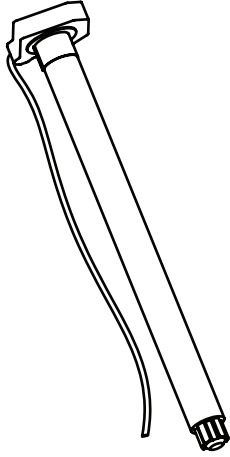

## Somfy LT50 RTS CMO - Radio Technology (Manual Override)

Part Number	Description	Unit
8016-MOTO-00-ST	525A2 RTS CMO ELC*: 97 lbs / 60 mm Oct. Tube, 20 rpm	PC
8028-MOTO-00-ST	530R2 RTS CMO ELC*: 117 lbs / 60 mm Oct. Tube, 14 rpm	PC
8026-MOTO-00-ST	535A2 RTS CMO ELC*: 136 lbs / 60 mm Oct. Tube, 20 rpm	PC
8031-MOTO-00-ST	540R2 RTS CMO ELC*: 156 lbs / 60 mm Oct. Tube, 14 rpm	PC
8032-MOTO-00-ST	550R2 RTS CMO ELC*: 195 lbs / 60 mm Oct. Tube, 14 rpm	PC

## Somfy LT50 CMO Motors

Part Number	Description	Unit
8017-MOTO-00-ST	525A2 CMO ELC*: 97 lbs / 60 mm Oct. Tube, 40% SF:20 rpm	PC
8025-MOTO-00-ST	530R2 CMO ELC*: 117 lbs / 60 mm Oct. Tube, 40% SF:14 rpm	PC
8030-MOTO-00-ST	535A2 CMO ELC*: 136 lbs / 60 mm Oct. Tube, 40% SF:20 rpm	PC
8036-MOTO-00-ST	540R2 CMO ELC*: 156 lbs / 60 mm Oct. Tube, 40% SF:14 rpm	PC
8040-MOTO-00-ST	550R2 CMO ELC*: 195 lbs / 60 mm Oct. Tube, 40% SF:14 rpm	PC

## Somfy LT60 CMO Motors

Part Number	Description	Unit
8046-MOTO-LT-60	660R2 CMO ELC*: 212 lbs / 70 mm Oct. Tube, 14 rpm	PC
8048-MOTO-LT-60	680R2 CMO ELC*: 280 lbs / 70 mm Oct. Tube, 14 rpm	PC
8050-MOTO-LT-60	6100R2 CMO ELC*: 352 lbs / 70 mm Oct. Tube, 14 rpm	PC

## Somfy LS40 Tubular Electric Motors

Part Number	Description	Unit
8011-MOTO-00-ST	409R2 ELC*: 59 lbs / 40 mm Round or 40 mm Oct/ 16 rpm	PC
8003-MOTO-00-ST	412R2 ELC*: 79 lbs / 40 mm Round or 40 mm Oct / 8 rpm	PC

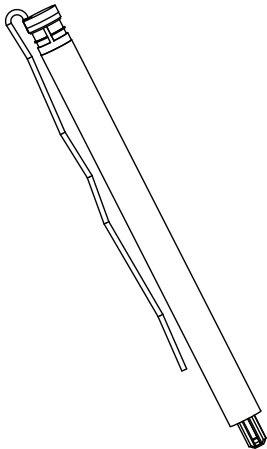

# SIMU MOTORS - REGULAR

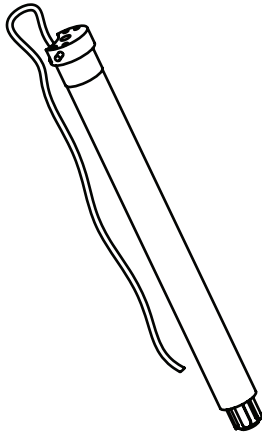

## Simu Type 5 Standard Motors

Part Number	Description	Unit
8063-MOTO-00-ST	510/12 ELC*: 38 lbs / 60 mm Octagonal Tube, 40% SF.12 rpm	PC
8064-MOTO-00-ST	515/18 ELC*: 58 lbs / 60 mm Octagonal Tube, 40% SF.18 rpm	PC
8070-MOTO-00-ST	520/12 ELC*: 77 lbs / 60 mm Octagonal Tube, 40% SF.12 rpm	PC
8066-MOTO-00-ST	525/18 ELC*: 97 lbs / 60 mm Octagonal Tube, 40% SF.18 rpm	PC
8080-MOTO-00-ST	530/12 ELC*: 117 lbs / 60 mm Octagonal Tube, 40% SF.12 rpm	PC
8090-MOTO-00-ST	535/18 ELC*: 136 lbs / 60 mm Octagonal Tube, 40% SF.18 rpm	PC
8095-MOTO-00-ST	540/12 ELC*: 155 lbs / 60 mm Octagonal Tube, 40% SF.12 rpm	PC
8099-MOTO-00-ST	550/12 ELC*: 194 lbs / 60 mm Octagonal Tube, 40% SF.12 rpm	PC

## Simu - Type 5 Radio Hz - 02 Plus Operators

Part Number	Description	Unit
8077-MOTO-00-ST	505/35 HZ ELC*: 20 lbs / 60 mm Oct. Tube, 40% SF.35 rpm	PC
8078-MOTO-00-ST	510/35 HZ ELC*: 38 lbs / 60 mm Oct. Tube, 40% SF.35 rpm	PC
8072-MOTO-00-ST	515/18 HZ ELC*: 58 lbs / 60 mm Oct. Tube, 40% SF.18 rpm	PC
8089-MOTO-00-ST	520/12 HZ ELC*: 77 lbs / 60 mm Oct. Tube, 40% SF.12 rpm	PC
8073-MOTO-00-ST	525/18 HZ ELC*: 97 lbs / 60 mm Oct. Tube, 40% SF.18 rpm	PC
8074-MOTO-00-ST	530/12 HZ ELC*: 117 lbs / 60 mm Oct. Tube, 40% SF.12 rpm	PC
8075-MOTO-00-ST	535/18 HZ ELC*: 136 lbs / 60 mm Oct. Tube, 40% SF.18 rpm	PC
8076-MOTO-00-ST	550/12 HZ ELC*: 194 lbs / 60 mm Oct. Tube, 40% SF.12 rpm	PC

## Simu Type 6 Standard Motors

Part Number	Description	Unit
8111-MOTO-00-ST	660/14 ELC*: 212 lbs / 70mm Oct. Tube, 40% SF.14 rpm	PC
8113-MOTO-00-ST	680/14 ELC*: 281 lbs / 70mm Oct. Tube, 40% SF.14 rpm	PC
8118-MOTO-00-ST	6100/14 ELC*: 352 lbs / 70 mm Oct. Tube, 40% SF.14 rpm	PC

## Simu Type 6 Radio Hz - 02 Plus Operators

Part Number	Description	Unit
8145-MOTO-00-ST	660/14 HZ ELC*: 212 lbs / 70 mm Oct. Tube, 40% SF. 14 rpm	PC
8146-MOTO-00-ST	680/14 HZ ELC*: 281 lbs / 70mm Oct. Tube, 40% SF. 14 rpm	PC
8147-MOTO-00-ST	6100/14 HZ ELC*: 352 lbs / 70 mm Oct. Tube, 40% SF. 14 rpm	PC

## Simu Type 5 DC Operators (Low Voltage Motors: 12 V and 24 V)

Part Number	Description	Unit
8079-MOTO-00-ST	Type 5 DC Operators T5 15 Nm 15 rpm 12 V	PC
8107-MOTO-00-ST	Type 5 DC Operator T5 35 Nm 7 rpm 12 V	PC
8112-MOTO-00-ST	Type 5 DC Operator T5 15 NM 15 rpm 24 V	PC

## Simu Type 3.5 DCE Hz Operator AUTOSUN

Part Number	Description	Unit
8092-MOTO-00-ST	AUTOSUN 10Nm 12 rpm 12 V + Battery + Solar Panel	PC

# SIMU MOTORS - DMI

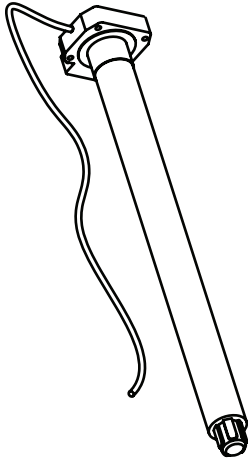

## Simu Tubular Type 5 Override Operators

Part Number	Description	Unit
8061-MOTO-00-ST	510 DMI ELC*: 38 lbs / 60 mm Oct. Tube, 40% SF.12 rpm	PC
8065-MOTO-00-ST	515 DMI ELC*: 58 lbs / 60 mm Oct. Tube, 40% SF.18 rpm	PC
8071-MOTO-00-ST	520 DMI ELC*: 77 lbs / 60 mm Oct. Tube, 40% SF.12 rpm	PC
8067-MOTO-00-ST	525 DMI ELC*: 97 lbs / 60 mm Oct. Tube, 40% SF.18 rpm	PC
8081-MOTO-00-ST	530 DMI ELC*: 117 lbs / 60 mm Oct. Tube, 40% SF.12 rpm	PC
8091-MOTO-00-ST	535 DMI ELC*: 136 lbs / 60 mm Oct. Tube, 40% SF.18 rpm	PC
8096-MOTO-00-ST	540 DMI ELC*: 155 lbs / 60 mm Oct. Tube, 40% SF.12 rpm	PC
8100-MOTO-00-ST	550 DMI ELC*: 194 lbs / 60 mm Oct. Tube, 40% SF.12 rpm	PC

## Simu Type 5 Radio Hz Override Operators

Part Number	Description	Unit
8082-MOTO-00-ST	515 DMI HZ ELC*: 58 lbs / 60 mm Oct. Tube, 40% SF.18 rpm	PC
8087-MOTO-00-ST	525 DMI HZ ELC*: 97 lbs / 60 mm Oct. Tube, 40% SF.18 rpm	PC
8083-MOTO-00-ST	530 DMI HZ ELC*: 117 lbs / 60 mm Oct. Tube, 40% SF.12 rpm	PC
8084-MOTO-00-ST	535 DMI HZ ELC*: 136 lbs / 60 mm Oct. Tube, 40% SF.18 rpm	PC
8085-MOTO-00-ST	550 DMI HZ ELC*: 194 lbs / 60 mm Oct. Tube, 40% SF.12 rpm	PC

## Simu Type 6 Override Operators

Part Number	Description	Unit
8101-MOTO-00-ST	660 DMI ELC*: 212lbs / 70 mm Oct. Tube, 40% SF.14 rpm	PC
8116-MOTO-00-ST	680 DMI ELC*: 281lbs / 70 mm Oct. Tube, 40% SF.14 rpm	PC
8119-MOTO-00-ST	6100 DMI ELC*: 352 lbs / 70 mm Oct. Tube, 40% SF.14 rpm	PC

## Simu Type 6 Radio Hz Override Operators

Part Number	Description	Unit
8148-MOTO-00-ST	660DMI HZ ELC*: 212 lbs / 70 mm Oct. Tube, 40% SF.14 rpm	PC
8149-MOTO-00-ST	680DMI HZ ELC*: 281 lbs / 70 mm Oct. Tube, 40% SF.14 rpm	PC
8150-MOTO-00-ST	6100DMI HZ ELC*: 352 lbs / 70 mm Oct. Tube, 40% SF.14 rpm	PC

## T8 - Heavy Duty Tubular Motor

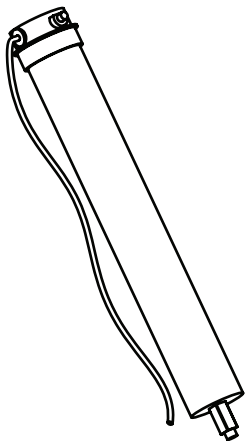

Part Number	Description	Unit
8069-MOTO-00-ST	Standard T8 Operator, 120 V, 10 rpm, 94 mm ID	PC
8068-MOTO-00-ST	DMI T8 Operator, 120 V, 10 rpm, 94 mm ID	PC

# ROLLAC MOTORS

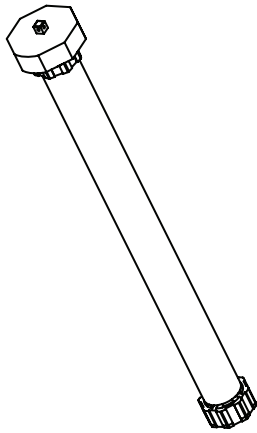

### Rollac Tubular Electric 50 NM Series Motors (Crown, Drive Included)

Part Number	Description	Unit
8161-MOTO-00-ST	550 Manual Override ELC 195 lbs / 60 mm / 14% / rpm 13	PC
8164-MOTO-00-ST	550 Radio Override ELC 195 lbs / 60 mm /14% / rpm 13 w/Remote	PC

### Rollac Tubular Electric 100 NM Series Motors (Crown, Drive, and Included)

Part Number	Description	Unit
8166-MOTO-00-ST	6100 Manual Override ELC 352 lbs / 70mm / 14% / rpm 12	PC
8168-MOTO-00-ST	6100 Radio Override ELC 352 lbs / 70 mm/14%/ rpm 12 w/Remote	PC

### Rollac Electronics / Li-Motors - 50 NM Series Override Motor Kit for 60 mm or 70 mm Octagonal Axle

Part Number	Description	Unit
8042-MOTO-00-ST	550 LI/ CMO ELC 195 lbs / 60 mm Oct Tube /40% SF / 13 rpm (550 LI Kit)	PC

# CROWNS & DRIVES

## Somfy and Simu Crowns and Drives - DS 78

 <p>8199</p>	Part Number	Description	Unit
	8198-ADAP-00-XX	CROWN - FOR LT50/500 Series 78 mm Round Awning Tube	PC
	8215-ADAP-00-XX	CROWN - FOR LT60/600 Series 78 mm Round Awning Tube	PC
	8199-ADAP-00-XX	DRIVE - FOR LT50/60 500/600 78 mm Round Awning Tube	PC

## Somfy and Simu Crowns and Drives - P 72

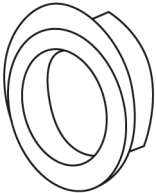
 <p>8200</p>	Part Number	Description	Unit
	8200-ADAP-00-XX	CROWN - FOR LT50/500 Series 72 mm Round Awning Tube	PC
	8197-ADAP-00-XX	CROWN - FOR LT60/600 Series 72 mm Round Awning Tube	PC
	8201-ADAP-00-XX	DRIVE - FOR LT50/60 500/600 72 mm Round Awning Tube	PC

## Somfy and Simu Drive - 2.0"

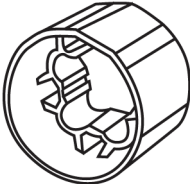
	Part Number	Description	Unit
	8195-ADAP-00-XX	DRIVE - FOR LT50/500 Series (Soft Clip) 50 mm Round Tube	PC

## Rollac Crowns, Drives, and Bracket

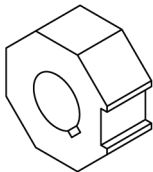
 <p>8178</p>	Part Number	Description	Unit
	8175-ADAP-00-PL	Plastic Crown Cap f/D-Motor to enlarge from 60 mm to 70 mm	PC
	8176-ADAP-00-PL	Plastic Drive Adaptor f/series 45 and 59 to 70 mm Axle	PC
	8177-BRCK-00-ST	10mm Bracket f/Reg Motors	PC
	8178-ADAP-00-AL	Aluminum Drive Adaptor f/70 mm Oct for D-Motor	PC

# SOMFY / SIMU CROWNS & DRIVES

## Somfy and Simu Crowns and Drives - 2.5"

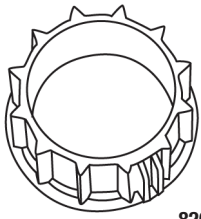
 <p>8204</p>	Part Number	Description	Unit
	8204-ADAP-00-XX	CROWN - FOR LT50/500 Series 63 mm Round Tube	PC
	8205-ADAP-00-XX	DRIVE - FOR LT50/60 500/600 63 mm Round Tube	PC

## Somfy and Simu Crowns and Drives - 2.75"

 <p>8216</p>	Part Number	Description	Unit
	8208-ADAP-00-XX	CROWN - FOR LT50/500 Series 70 mm Round Tube	PC
	8209-ADAP-00-XX	DRIVE - FOR LT50/60 500/600 70 mm Round Tube	PC
	8210-ADAP-00-XX	CROWN - FOR LT60/600 Series 70 mm Round Tube	PC
	8216-ADAP-00-XX	DRIVE - DS78/R FOR LT60/ 600 78 mm Round Awning Tube	PC

## Somfy and Simu Crowns and Drives - 2.375"

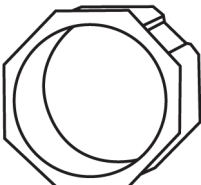
 <p>8223</p>	Part Number	Description	Unit
	8223-ADAP-00-XX	CROWN - For LT50/500 Series 60 mm Octagonal Tube	PC
	8224-ADAP-00-XX	DRIVE - For LT50/500 Series 60 mm Octagonal Tube	PC

## Somfy and Simu Crowns - 2.75"

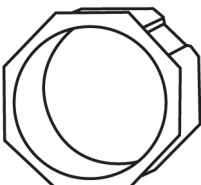
 <p>8233</p>	Part Number	Description	Unit
	8228-ADAP-00-XX	CROWN - For LT50/500 Series 70 mm Octagonal Tube	PC
	8233-ADAP-LT-60	CROWN - For LT60/600 Series 70 mm Octagonal Tube	PC

## Crown And Drives For 400 Series Motor - Somfy

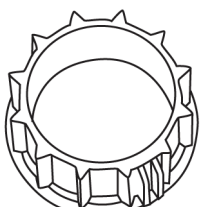
 <p>8240</p>	Part Number	Description	Unit
	8240-ADAP-00-XX	Crown for 40 mm Octagonal Tube	PC
	8241-ADAP-00-XX	Drive for 40 mm Octagonal Tube	PC
	8242-ADAP-00-XX	Crown for 40 mm Round Tube	PC
	8243-ADAP-00-XX	Drive for 40 mm Round Tube	PC

# SOMFY / SIMU CROWNS & DRIVES

## Somfy and Simu Drives - 2.75"

 <p style="text-align: center;">8235</p>	Part Number	Description	Unit
	8234-ADAP-LT-60	DRIVE - For LT50/60 500/600 70 mm Octagonal Tube	PC
	8235-ADAP-LT-AL	DRIVE - For LT50/60 500/600 70 mm Oct. Tube (ALUM)	PC

## Somfy and Simu Crowns and Drives - 3.5"

 <p style="text-align: center;">8246</p>	Part Number	Description	Unit
	8245-ADAP-00-XX	CROWN - For LT60/600 Series 89 mm Round Tube	PC
	8246-ADAP-00-XX	DRIVE - For LT50/60 500/600 89 mm Round Tube	PC

## Somfy and Simu Crowns and Drives - 4.0"

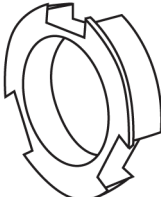
 <p style="text-align: center;">8249</p>	Part Number	Description	Unit
	8249-ADAP-00-XX	CROWN - For LT60/ 600 Series 100 mm Round Tube	PC
	8250-ADAP-00-XX	DRIVE - For LT60/ 600 Series 100 mm Round Tube	PC

## Selve Crown and Drive Kit - 2.0 For 50 mm Octagonal Selve Tube

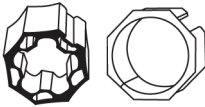
	Part Number	Description	Unit
	8264-ADAP-00-XX	For LT50/ 500 Series Motor	PC

# MOTOR BRACKETS

## T8 Drive, Bracket, Idler

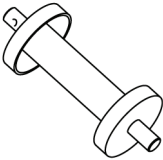
 <p>8259</p>	Part Number	Description	Unit
	8279-ADAP-00-XX	T8 94 mm Round Drive	PC
	8370-BRCK-00-ST	T8 Bracket Angle 2 Pc Set	PC
	8259-SWIT-00-XX	94 mm Idler Insert	PC

## Somfy Motor Brackets for Standard and Standard RTS

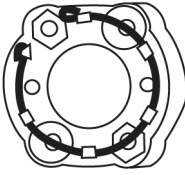
 <p>8311</p>	Part Number	Description	Unit
	8311-BRCK-LT-60	Universal Motor Bracket With Spring Ring LT50 LT60	PC
	8316-BRCK-00-ST	For BK-45 250S (10") & 300S (12") Side Cap 4" x 4"	PC
	8318-BRCK-00-ST	LT50/60 Standard Motor Bracket With Conduit Connector	PC
	8326-BRCK-00-ST	"HA" Plate With Motor Bracket For LT50 And LT60	PC
	8330-BRCK-00-ST	Spring Ring Used With All Brackets For LT50 & LT60	PC

## Operator Bracket Type DMI Override for Simu

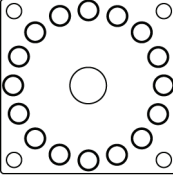
	Part Number	Description	Unit
	8351-BRCK-00-ST	DMI Bracket 100 mm x 100 mm	PC

## Connecting Sleeve

	Part Number	Description	Unit
	8055-ACCE-00-ST	7 mm Hexagon To 8 mm Square Rod	PC
	8056-ACCE-00-ST	For 8 mm Square Rod	PC

## Stainless Steel M6 Nut and Bolt For CMO and DMI Motor

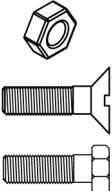
	Part Number	Description	Unit
	8059-ACCE-00-ST	M6-1.0 Hex Nut	PC
	8054-ACCE-00-ST	M6-1.0 x 25 Hex Cap Screw	PC
	8058-ACCE-00-ST	M6-1.0 x 25 Flat Phil Screw	PC

# BRACKETS

**Special Bracket for Sidecaps for Simu**

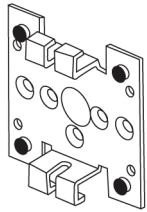
	Part Number	Description	Unit
	8356-BRCK-00-ST	For 500 Series Motors, Dimensions: 3.5" x 3.5"	PC

**Special Bracket for BK- 45 250/S (10") & BK- 45 300/S (12") Sidecaps for Simu**

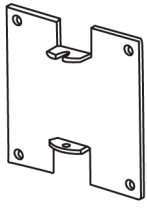
	Part Number	Description	Unit
	8358-BRCK-00-ST	For 500 Series Motors, Dimensions: 4.0" x 4.0"	PC

**U - Bracket**

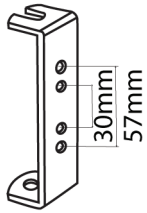
 <p style="text-align: center;">8362</p>	Part Number	Description	Unit
	8362-BRCK-00-ST	For 600 Series Motors	PC
	8352-BRCK-00-ST	For 500 Series Motors, With Holes 30 mm Apart	PC

**Special Bracket For BK- 45 250/S (10") & BK- 45 300/S (12") Sidecaps for Simu**

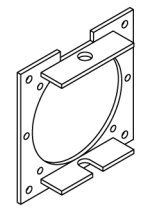
	Part Number	Description	Unit
	8364-BRCK-00-ST	For 600 Series Motors Dimensions: 4" x 4"	PC

**Idler End Cap, Heavy Duty and Support Bracket for T-8 Motors**

	Part Number	Description	Unit
	8325-BRCK-00-ST	Support Bracket For Idler End Cap	PC