

# Section 6

## Pulleys & Recoil Boxes

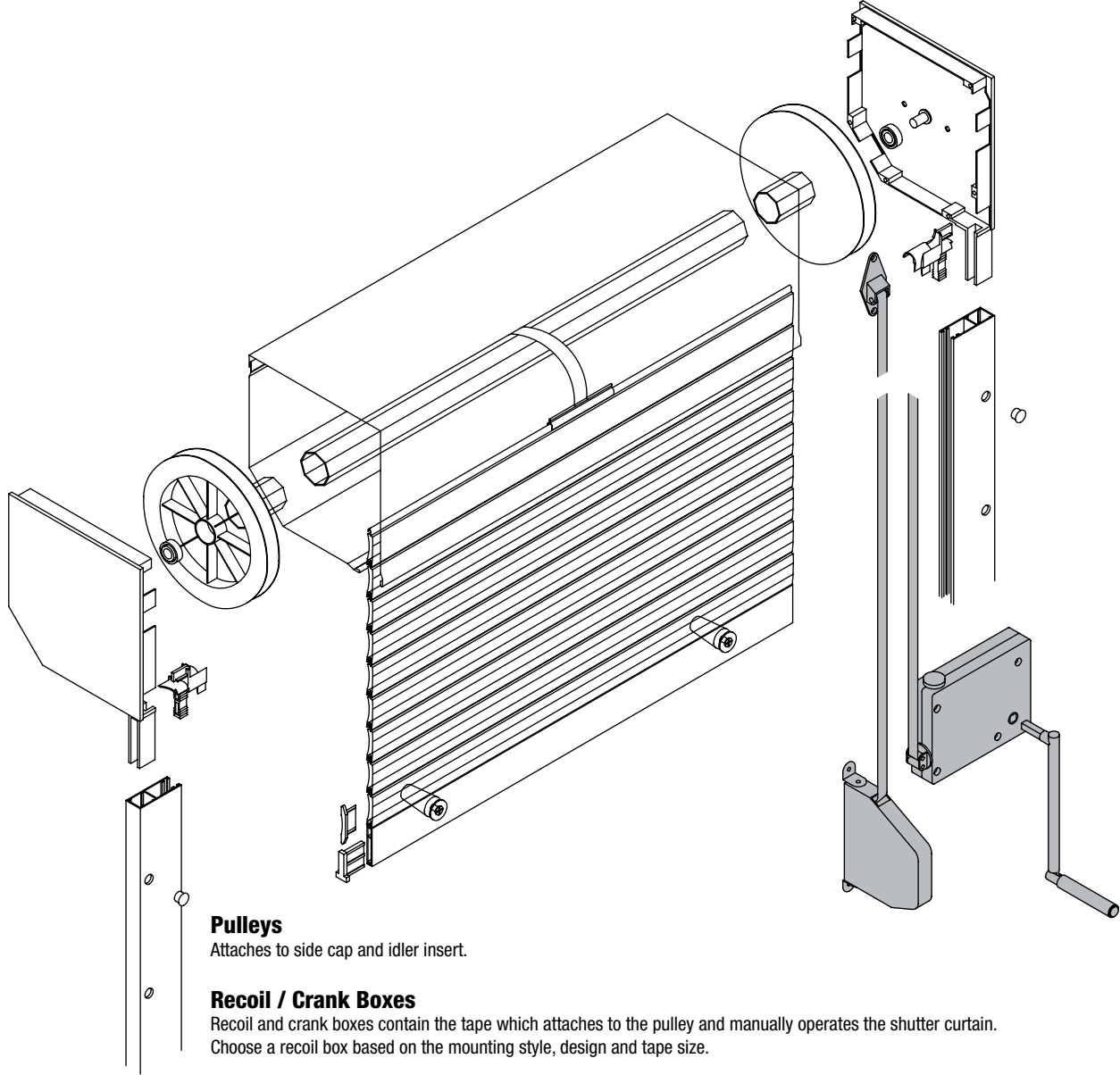

### Pulleys

Attaches to side cap and idler insert.

### Recoil / Crank Boxes

Recoil and crank boxes contain the tape which attaches to the pulley and manually operates the shutter curtain. Choose a recoil box based on the mounting style, design and tape size.

### Tape Guides

Tape guides align the recoil box tape in line with the pulley.

### Tape

Tape is the physical operator around the pulley that turns the axle. Ensure the tape type chosen is long and strong enough to support manual operation of a shutter.

# PULLEYS

### Mini Plastic Pulleys for 40 mm Octagonal Tube and 28 mm Bearing

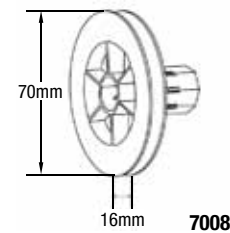
 <p>70mm 16mm <b>7008</b></p>	Part Number	Description	Unit
	7008-PULL-00-PL	Ø 80 mm	PC
	7011-PULL-00-PL	Ø 100 mm	PC
	7012-PULL-00-PL	Ø 115 mm	PC
	7014-PULL-00-PL	Ø 125 mm	PC
	7016-PULL-00-PL	Ø 140 mm	PC
	7020-PULL-00-PL	Ø 155 mm	PC
	7021-PULL-00-PL	Ø 170 mm	PC
	7023-PULL-00-PL	Ø 190 mm	PC

### Mini Plastic Pulleys for 40 mm and 60 mm Octagonal Telescopic Caps #4230 And #4243

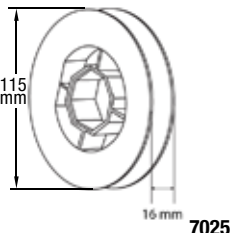
 <p>115mm 16mm <b>7025</b></p>	Part Number	Description	Unit
	7025-PULL-00-PL	Ø 115 mm	PC
	7030-PULL-00-PL	Ø 125 mm	PC
	7035-PULL-00-PL	Ø 140 mm	PC
	7040-PULL-00-PL	Ø 155 mm	PC
	7045-PULL-00-PL	Ø 170 mm	PC
	7050-PULL-00-PL	Ø 190 mm	PC

### 1:2 Mini Reduction Gear for 14/15 mm Tape, Requires Insert #6110, #6111 #6115, #6122 Or # 6131

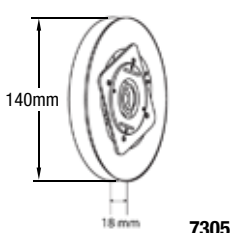
 <p>140mm 18mm <b>7305</b></p>	Part Number	Description	Unit
	7305-PULL-00-PL	Ø 140 mm	PC
	7310-PULL-00-PL	Ø 170 mm	PC

# RECOIL BOXES

### Mini Recoil Boxes Swivel Mount, with Mini Tape 15 mm X 1 mm X 5.5 mtr

 <p>7415</p>	Part Number	Description	Unit
	7415-RBOX-06-PL	White Box / Grey Tape	PC
	7416-RBOX-22-PL	Brown Box / Brown Tape	PC
	131 mm x 118 mm x 20 mm L = 154 mm		

### Mini Recoil Boxes Swivel Mount, Without Tape

	Part Number	Description	Unit
	7420-RBOX-06-PL	White Box / Without Tape	PC

### Mini Recoil Boxes - Swivel Mount, with Mini Tape 15 mm X 1 mm X 7 mtr

 <p>7417</p>	Part Number	Description	Unit
	7417-RBOX-06-PL	White Box / Grey Tape	PC
	7418-RBOX-22-PL	Brown Box / Brown Tape	PC
	146 mm x 118 mm x 21 mm L = 167 mm		

### Mini Recoil Boxes For Reduction Gear, Swivel Mount, Without Tape

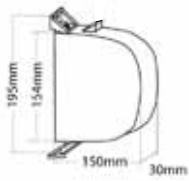
	Part Number	Description	Unit
	7425-RBOX-06-PL	White Box / Without Tape	PC

### Mini Recoil Boxes For Reduction Gear, Swivel Mount, With Mini Tape 14 mm X 1 mm X 9 mtr

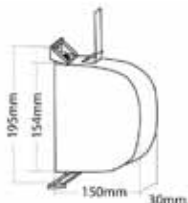
 <p>7423</p>	Part Number	Description	Unit
	7423-RBOX-06-PL	White Box / Grey Tape	PC
	7424-RBOX-22-PL	Brown Box / Brown Tape	PC

# RECOIL BOXES

### Mini Recoil Box Center Split, Swivel Mount, With Mini Tape 15 mm X 1 mm X 5 mtr

	Part Number	Description	Unit
	7433-RBOX-06-PL	White Box / Grey Patterned Tape	PC

### 1 : 3 Mini Rope Crank Box

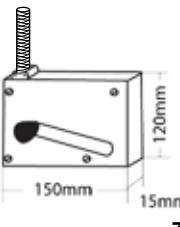
	Part Number	Description	Unit
	7510-RBOX-06-PL	White Box / White Rope 17 ft / 5.18 meters	PC
	7512-RBOX-22-PL	Brown Box / Brown Rope 17 ft / 5.18 meters	PC

### 1:3 Mini Strap Crank Box - One Outlet without Tape

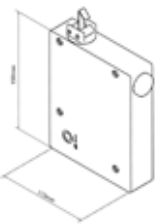
	Part Number	Description	Unit
	7519-RBOX-06-PL	Without Tape	PC

### 1:3 Mini Strap Crank Box - Two Outlets with Mini Tape 15 mm X 1 mm X 5.5 mtr

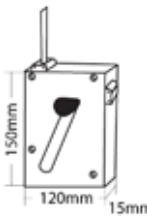
	Part Number	Description	Unit
	7520-RBOX-06-PL	White Box / Grey Tape With White Edges	PC
	7522-RBOX-22-PL	Brown Box / Brown Tape	PC

### 1:4 Gear Recess Mount Without Tape

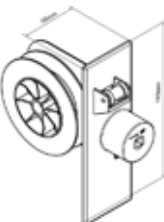
	Part Number	Description	Unit
	7525-RBOX-06-ST	Flush Fit, White Without Tape	PC

# CRANKS

### Crank Handles - Rigid Chrome For #7510, #7512, #7519, #7520 & #7522

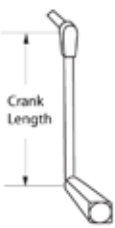
	Part Number	Description	Unit
	7530-HAND-24-ST	Crank Length = 130 mm Chrome-Black	PC
	7531-HAND-24-ST	Crank Length = 170 mm Chrome-Black	PC

### Crank Handles Spring Loaded - Chrome For #7510, #7512, #7519, #7520 & #7522

	Part Number	Description	Color	Unit
	7534-HAND-24-ST	Crank Length = 140 mm	Chrome-White	PC
	7535-HAND-24-ST	Crank Length = 180 mm	Chrome-Black	PC
	7536-HAND-24-ST	Crank Length = 180 mm	Chrome-White	PC

### Rope Guides

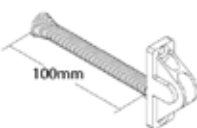
 <p>7439</p>	Part Number	Description	Unit
	7439-RBOX-06-PL	For #7510 White	PC
	7440-RBOX-22-PL	For #7512 Brown	PC

# GUIDES

### Mini Tape Guides for 14 / 15 mm Tape

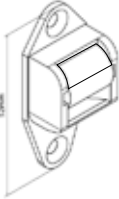
	Part Number	Description	Color	Unit
	7600-GUID-06-PL	With Brush & Iron Roll	White	PC
	7601-GUID-06-PL	With Brush & PVC Roll	White	PC

### Mini Tape Guides for 14 / 15 mm Tape Diamond Shape

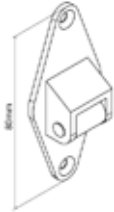
	Part Number	Description	Color	Unit
	7614-GUID-06-PL	With Brush & PVC Roll	White	PC
	7617-GUID-22-PL	With Brush & PVC Roll	Dark Brown	PC

### Mini Tape Guides For 14 / 15 mm Tape King Type

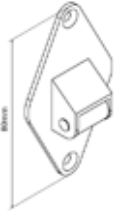
	Part Number	Description	Color	Unit
	7620-GUID-06-PL	With Brush & Needle Bearings	White	PC

### Mini Tape Guides for 14 / 15 mm Tape with Snap-On Cover

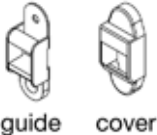
 <p>guide      cover</p> <p>7625</p>	Part Number	Description	Color	Unit
	7625-GUID-06-PL	With Brush & PVC Roll	White	PC
	7626-GUID-22-PL	With Brush & PVC Roll	Dark Brown	PC

### Mini Tape Guides for Side Caps

	Part Number	Description	Color	Unit
	7630-GUID-06-PL	With Brush & Nylon Roll	White	PC
	7631-GUID-22-PL	With Brush & Nylon Roll	Dark Brown	PC

# TAPE

### Mini Tape - Polypropylene: 14 mm X 1.2 mm

 <p>Roll = 165ft</p>	Part Number	Description	Unit
	7700-TAPE-06-PL	White	FT
	7705-TAPE-07-PL	Grey (Silver)	FT
	7710-TAPE-22-PL	Brown	FT
	7720-TAPE-04-PL	Cream with White Edge	FT

### Mini Tape - Polypropylene: 15 mm X 1.2 mm

 <p>Roll = 165ft</p>	Part Number	Description	Unit
	7715-TAPE-06-PL	White with Black Dots	FT
	7718-TAPE-07-PL	Grey with White Edge	FT

### Micro Tape - Polypropylene: 10 mm X 1.2 mm

 <p>Roll = 165ft</p>	Part Number	Description	Unit
	7725-TAPE-07-PL	Silver / Grey Tape	FT
	7726-TAPE-22-PL	Brown Tape	FT

### Maxi Tape - Polypropylene: 25 mm X 1.2 mm

 <p>Roll = 165ft</p>	Part Number	Description	Unit
	7760-TAPE-07-PL	Cream	FT